

Verstärker
Amplifier

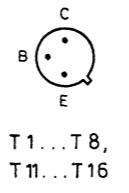

R3 (100...300µV)

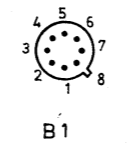
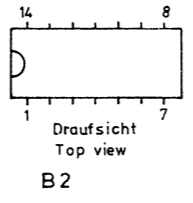
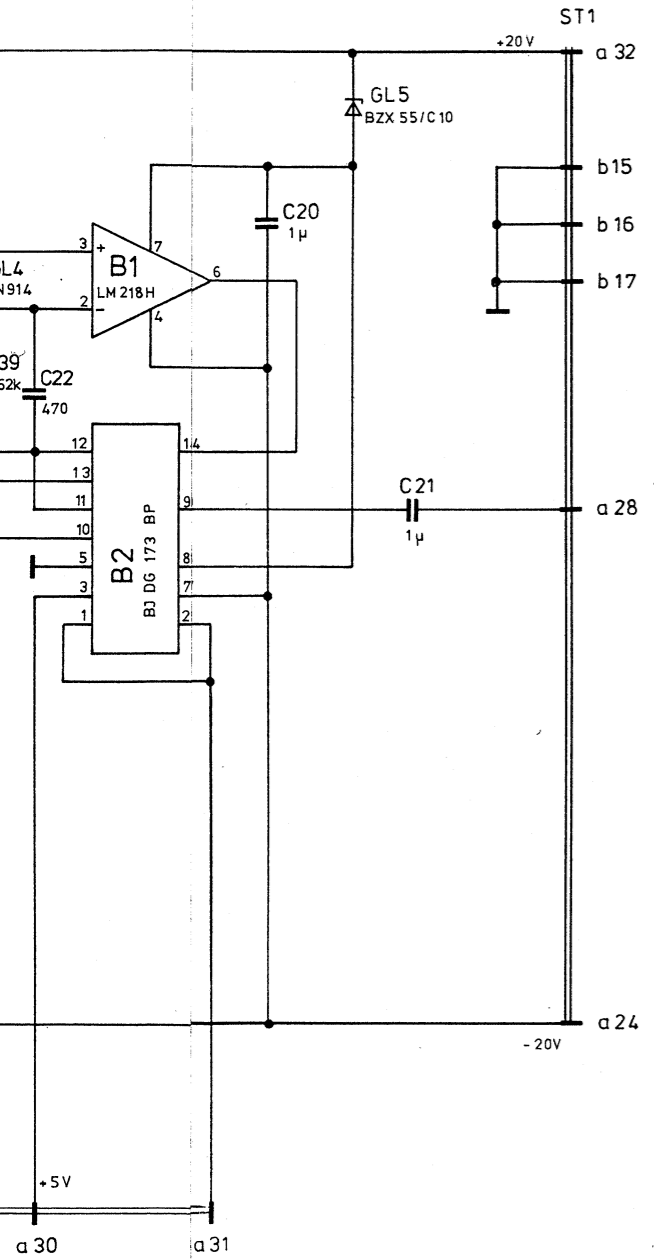
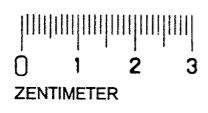

	Vorverstärker - B		Zeichn. Nr. 291.5219 S	
	Pre - Amplifier B		291.4012V	291.4012

Elektronischer Schalter
Electronic switch

90 dB-Verstärker
90 dB-Amplifier

Umschaltbarer 20dB Verstärker
Switch able 20dB Amplifier

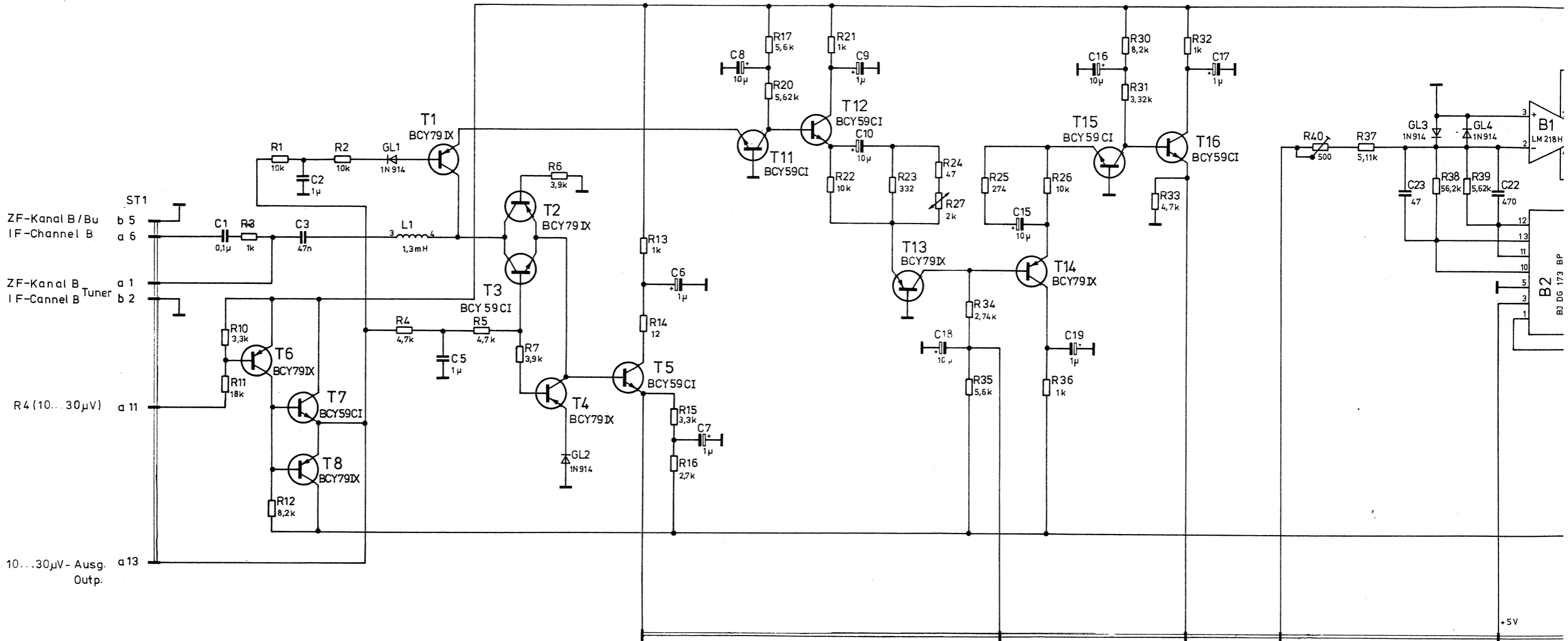

ST1 a9
ZF Ausg.
IF Outp.

a 18
Test
Meßp.

a 20
Vorverst. Ausg.
Pre-Amplifier Outp.

a 26
ZF-Eing.
IF-Inp.

a 30
+5V

Name	
Datum	
And. Nr.	
And. zuef.	
Name	
Datum	
And. Nr.	
And. zuef.	

Diese Zeichnung ist unser Eigentum. Vervielfältigung, Verbreitung, Weitergabe, Nachahmung, Entwertung, Verstoß und Schädigung sind strafbar und schadenersatzpflichtig.

ROHDE & SCHWARZ · MÜNCHEN

Name	Hg	Wg
Datum	24.5.77	
And. Nr.	A 23724	
And. zuef.		
Name		
Datum		
And. Nr.		
And. zuef.		
Name		
Datum		
And. Nr.		
And. zuef.		

Ansicht und Leitungsführung Bauteilseite
View of tracks on component side

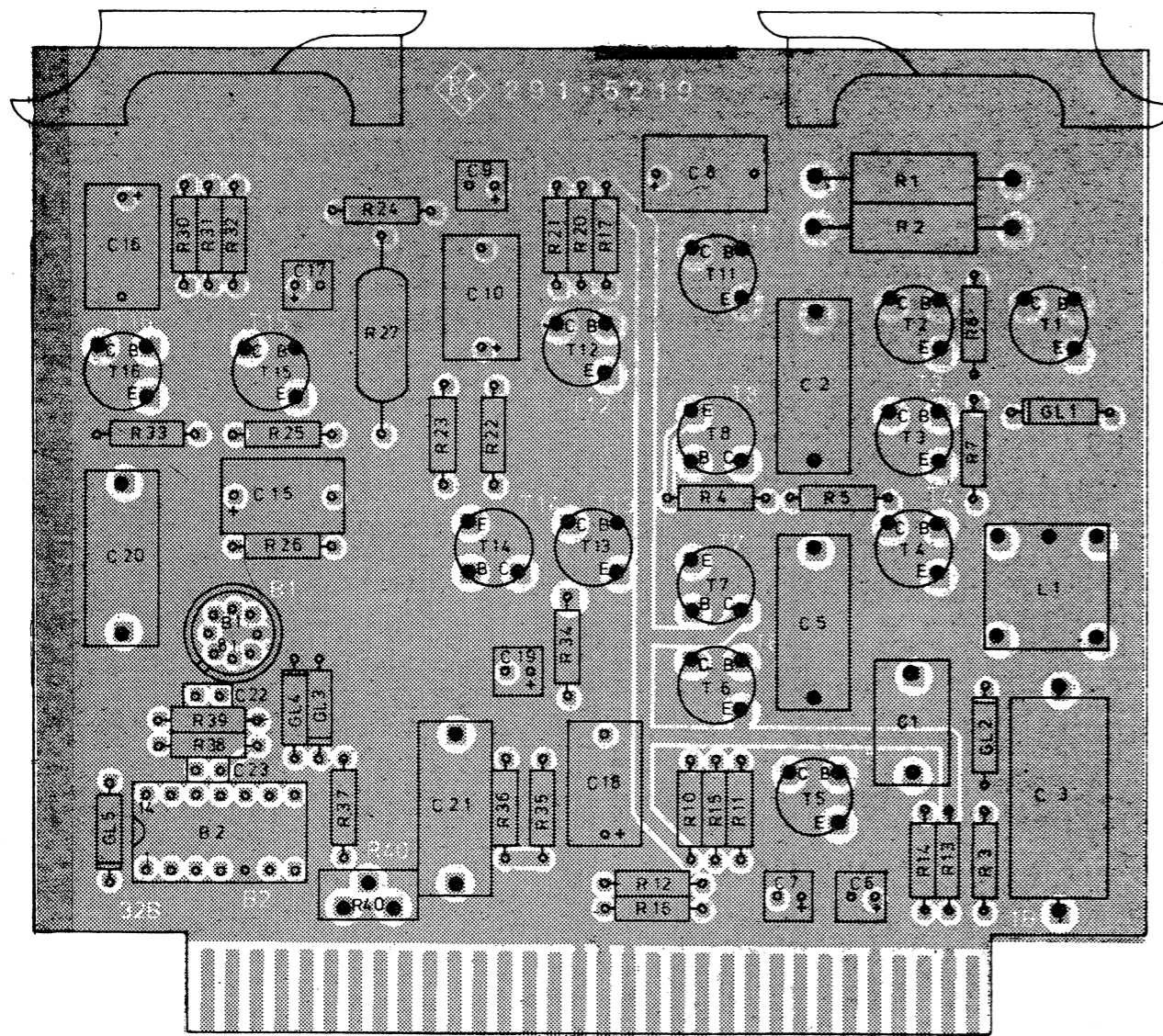

Ansicht und Leitungsführung Lötseite
View of tracks on solder side.

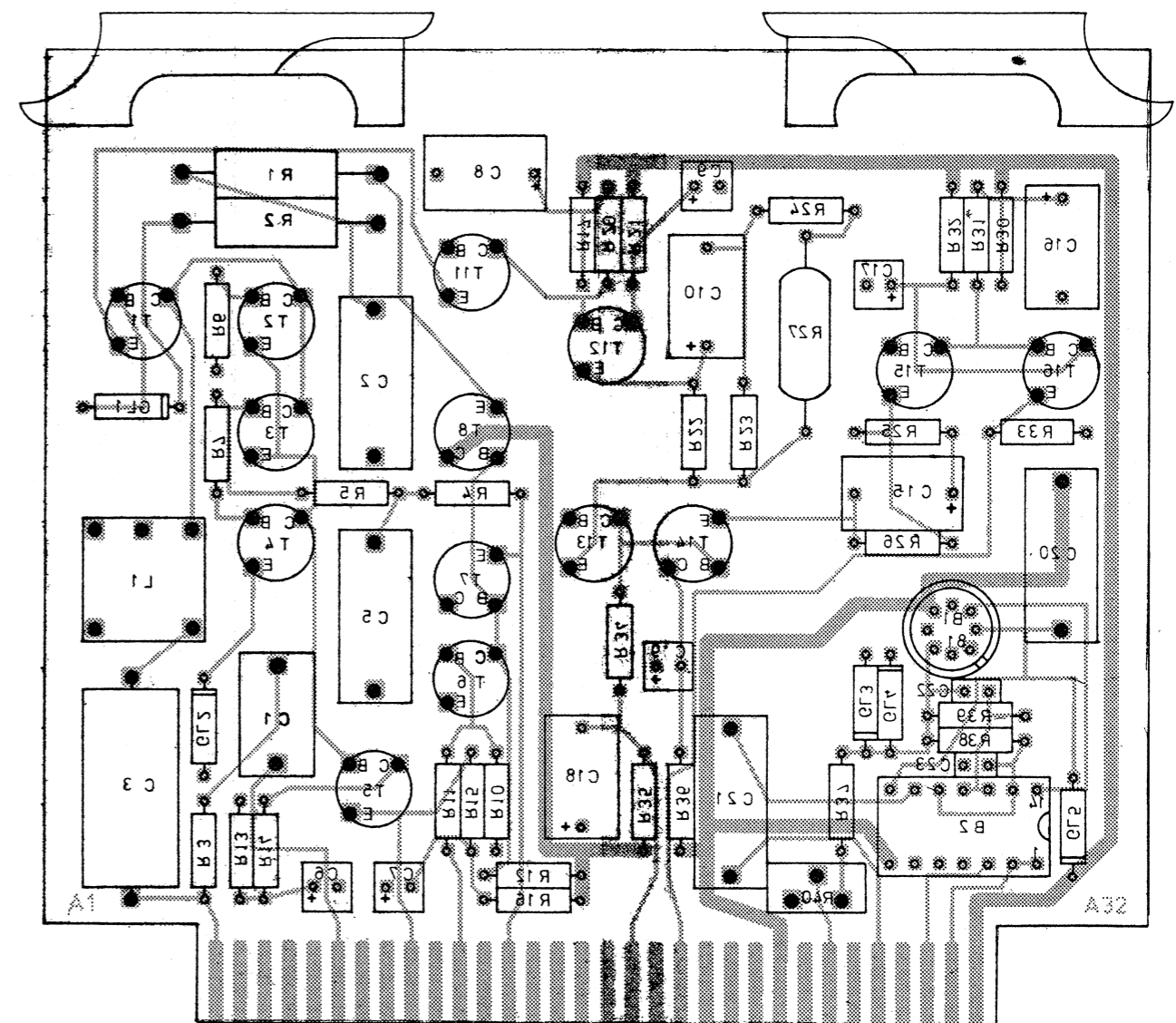

Blatt-Nr. 2

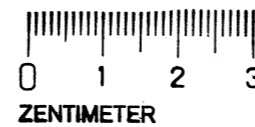

 ROHDE & SCHWARZ MÜNCHEN		Fertigung Werkstoff		Untolerierte Maße		Zeichn. Nr. 291.5219			
		Datum 20.6.77		Name Nk		Datum 20.6.77		Name Nk	
gezeichnet		bearbeitet		geprüft		normgepr.		Maßstab	
1GME		20.6.77		Nk		20.6.77		Nk	
20.6.77		B		21.6.77		W/G III		Vorverstärker B Pre - amplifizier B	
24737		Li		12.79		Li		Z	